

Canale attrezzato

Canali attrezzati

Codice: 3025 800



CARATTERISTICHE

LAVELLI DI SPESSORE

Acciaio spesso 1 mm. Uno spessore importante che garantisce la massima robustezza per lavelli che non conoscono i segni del tempo.

DETTAGLI

Bordo Installazione

Sopratop | Filotop

Materiale

Acciaio inox AISI 304

Finitura

Spazzolato Foster

Texture

Spazzolatura in linea

Base

90 cm

Dimensioni esterne

870 x 170 mm

Dimensioni interne

842 x 142 mm

Larghezza 87 cm

Lunghezza 6 unità - Standard

Foro incasso Vedi scheda tecnica

Dotazioni standard Ganci di fissaggio, guarnizione, piletta, imballo in scatola

Piletta Piletta 1¼"

Chiave di lettura per gli accessori Le lunghezze dei canali e degli accessori sono indicate in "unità", per la composizione la somma delle "unità" degli accessori deve corrispondere alla lunghezza in "unità" del canale.

DATI TECNICI

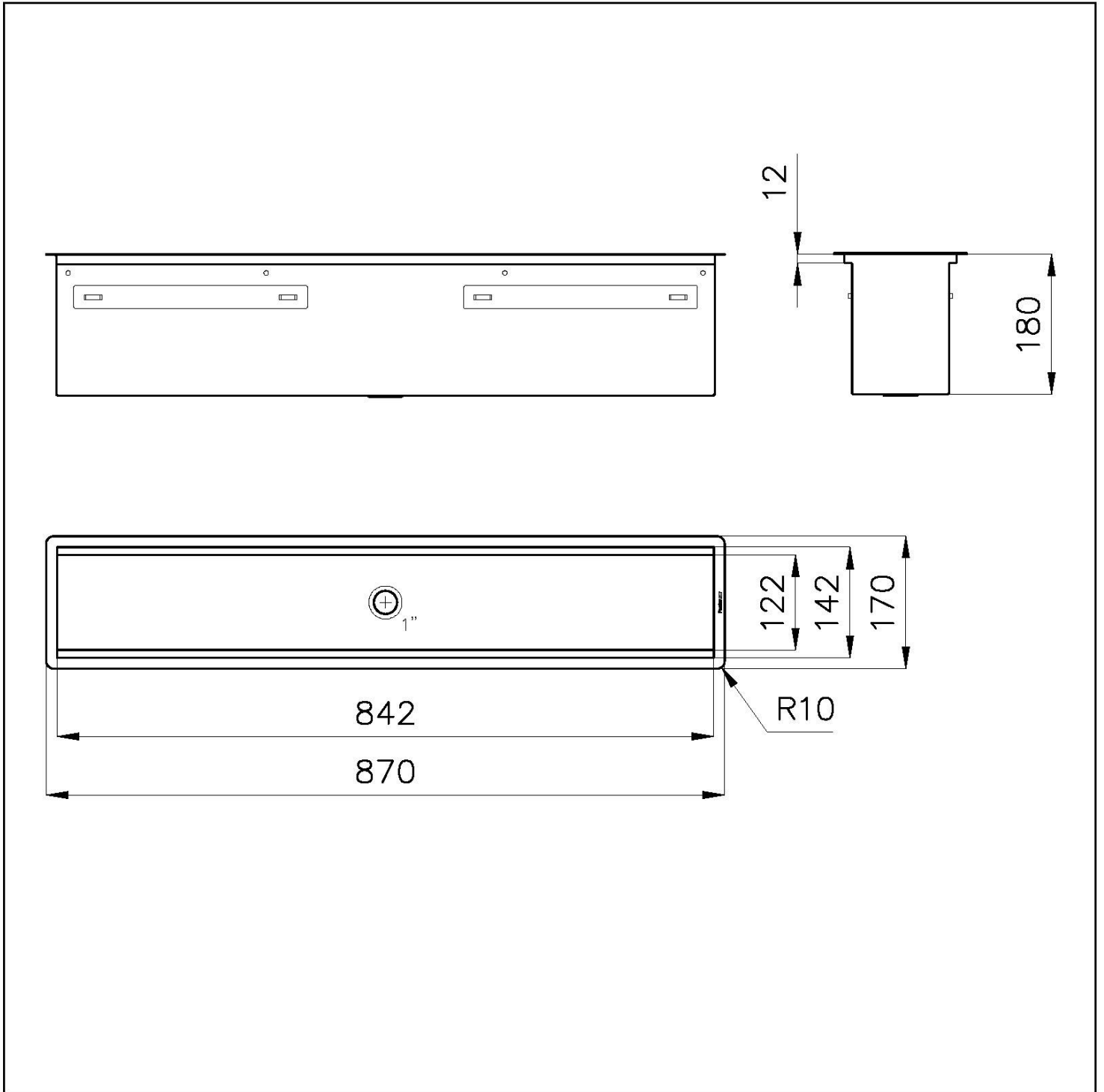

Filotop/Flush-mount

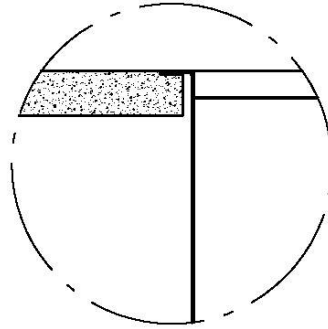

B-B:
Dettaglio installazione
Installation detail

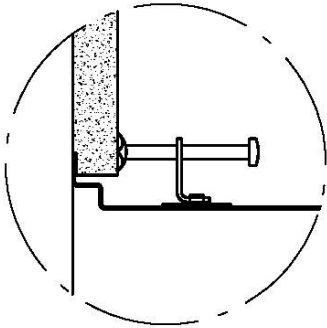

A-A:
Dettaglio installazione e sistema di fissaggio
Installation detail and fixing system

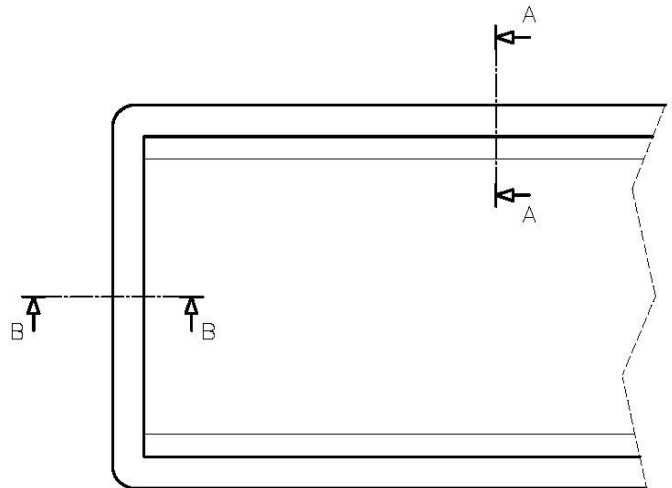

Dimensioni per foratura top
Cut out size

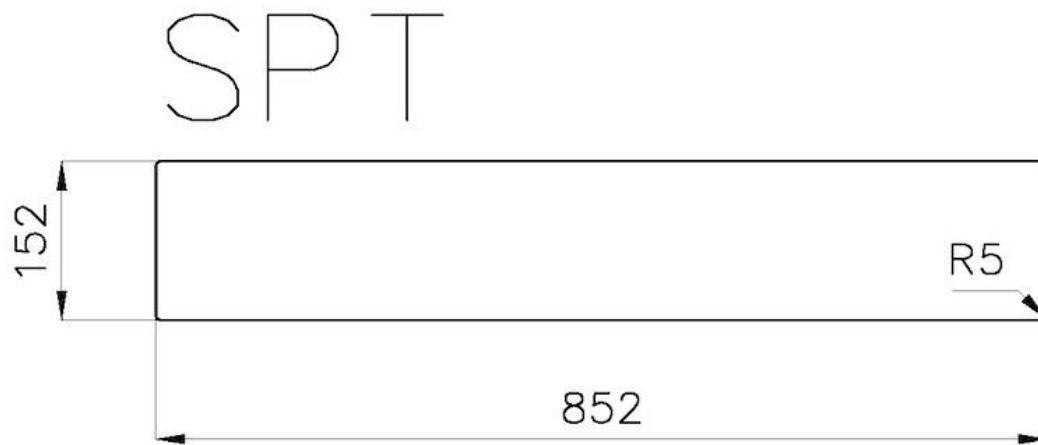
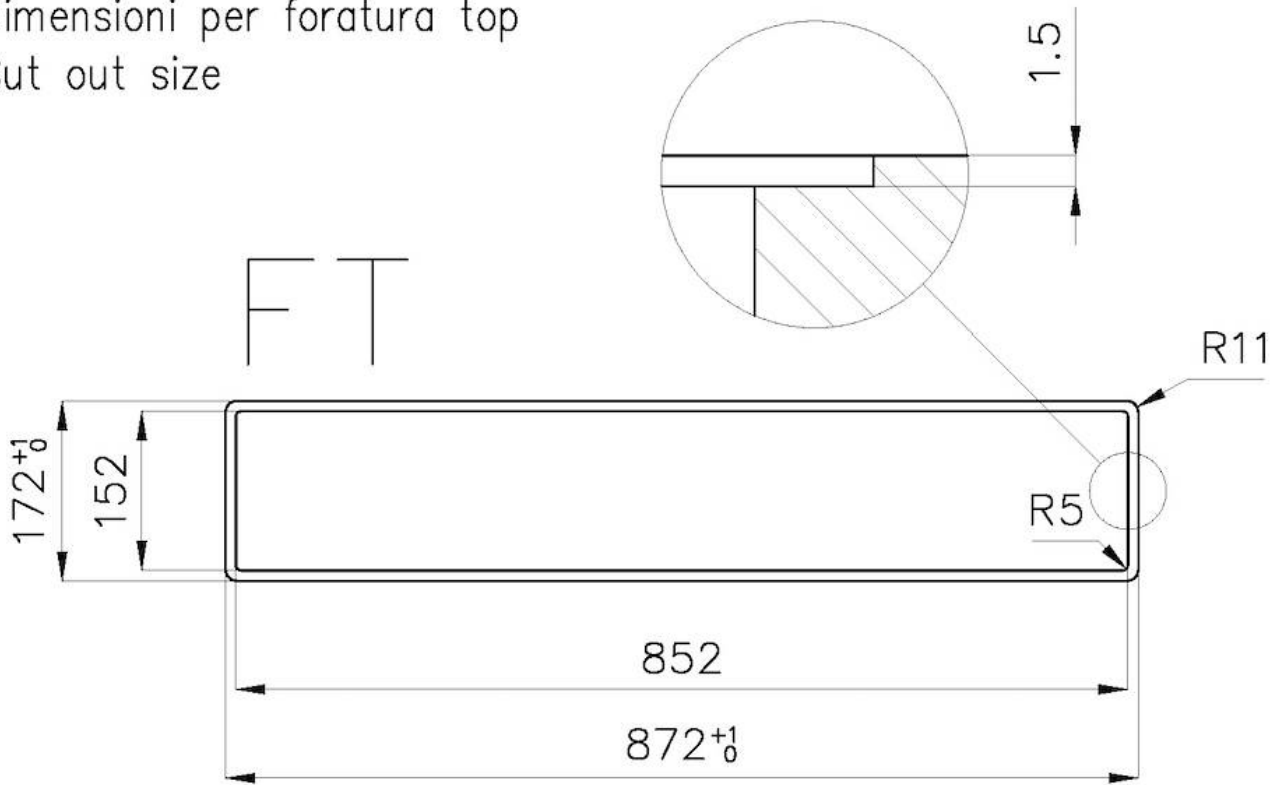

GALLERIA FOTOGRAFICA



ACCESSORI OPZIONALI



Gocciolatoio Black
8100 058



Kit "A"
8100 703



Kit "B"
8100 700



Kit "C"
8100 701



Kit "D"
8100 704



Kit "E"
8100 705



Kit "F"
8100 706



Kit "G"
8100 710



Kit "H"
8100 702



Kit "N"
8100 714



Portacoltelli inox
8100 712



Portapiatti inox
1773 100



Portaprese inox
8000 020



Vaschetta forata inox
8151 003